



**Automatic
Electric Ltd.**

Power System
Division



Dry Type Lighting Transformer

**Servo Controlled
Automatic Voltage
Stabilizer/Regulator**

Dimmerstat[®]

Continuously Variable
Voltage Auto-Transformer

AC STEP-SYN MOTOR Rectifier Unit

ULTRA ISOLATION TRANSFORMER

Oil Cooled Low Tension Transformer

Continuously Variable Voltage Auto-Transformer

DESCRIPTION

'Dimmerstat' is registered trademark for continuously variable voltage auto - transformer. It is the most effective device for stepless, breakless & continuous control of AC voltage & therefore for various parameters, dependent on AC voltage.

The basic Dimmerstat is meant for operation from a nominal input voltage of 240V AC & can give output voltage anywhere between 0 to 240V or 0 to 270V AC by simple transformer action. Three such Dimmerstat connected electrically in star and mechanically in tandem, become suitable for operation from a nominal input voltage of 415V 3Ph AC and can give output anywhere between 0 to 415V or 0 to 470V.

Resin moulded Dimmerstat is basically a variable Auto-Transformer which is partly or fully Moulded in Reinforced Polyester Resin. This has adjustable spindles which allows easy assembling of flush, table or Motorized Type in single or three phase models. These models are designed upto 120% continuous load.

FEATURES

- Simple, rugged construction.
- Coils made from high grade CRGO Silicon Steel & 99.9% pure copper.
- Output voltage variation is smooth, continuous, breakless & linearly proportional to angular rotation.
- High efficiency.
- Negligible waveform & power factor distortion.
- Excellent short time overload capacity.
- Remote operation possible by motorization.
- Wide range of current ratings.
- High quality carbon brush used for current collection.

ELECTRICAL SPECIFICATIONS

- MODEL : a) Flush Open Manual (Air Cooled) — F
b) Portable Enclosed Manual (Air Cooled) — P
c) In Tank Manual (Oil Cooled) — T
'F', 'P', 'T' suffixed by 'M' means motor operated models.
- OPERATING VOLTAGE : For Single Phase — 240V AC, 50 - 60 Hz, 1 ϕ .
For Three Phase — 415V AC, 50 - 60 Hz., 3 ϕ - 4wire.
- CURRENT RATINGS : For Oil Cooled models, maximum current & continuous current are one & the same.
For Air Cooled models, the ratings are as shown below

Maximum Current	0.7	2	4	8	10	15	20	28
Continuous Current	0.6	1.8	3.8	6.5	9	11.5	16	22

- OPERATING TEMP. : 0° - 45°C.
- INSULATION RESISTANCE : Not less than 5M ohms at 500V DC.
- DIELECTRIC TEST : 2.5kV RMS for 1 minute.
- STORAGE TEMP. : -9°C to 70°C
- HUMIDITY : Upto 95% RH
- CONFORMS TO : I.S. 5142.

- Notes:** 1) As output voltage is continuously variable, Dimmerstats are rated in terms of current that can be drawn from the output.
2) Oil should be Transformer Oil conforming to IS 335, IEC 296.



RESIN-CAST



Continuously Variable Voltage Auto-Transformer

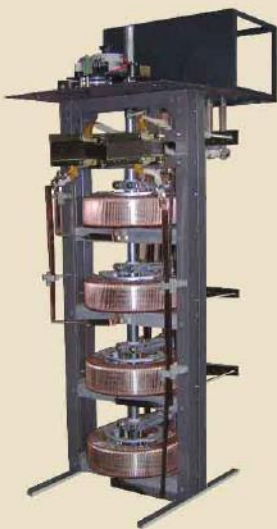

MECHANICAL CONSTRUCTION

Single phase Dimmerstats are available in 3 types.

- Portable type (P) with sheet steel enclosure for floor / table mounting.
- Flush type (F) with open type construction. Suitable for panel mounting.
- Tank type (T) immersed in oil in sheet steel tank with roller mounting.

Three phase Dimmerstat are usually ganged assemblies of 3 coils available in all 3 types: P, F, T.

Higher rating Dimmerstat (above 200 Amps) use 2/3 or more coils in parallel with load balancing arrangements.

Motorised Dimmerstat uses 240V AC Step-Syn Motor having 60 rpm speed at 50Hz. With proper gearing higher torque at lower speed can be achieved. Standard gear ratios used provide sweep time of 8, 15, 30, 45, 60, 120secs.

APPLICATIONS

- Auditorium, Hotels, Conference Halls, Exhibitions, Laboratories etc.,
- AC Voltage Stabilizers, Rectifiers, Battery Chargers.
- Temperature control of Ovens, Furnaces.
- Testing of Instruments, Relays, Circuit Breakers etc.
- Welding, Electro-plating, Anodizing etc.
- Colleges & Universities.

Ordering information

(as per code specified below)

1 st block	Output current rating amps	0.7,2,4,8,10,15,20,28,40,50,60,75,100,125,150,200,300,400,500,600,800,1000,1200,1600A
2 nd block	Dimmerstat (D)	Continuously variable voltage auto transformer.
3 rd block	No. of coils	1,2,3,4,6,9,12,15, 30, 45
4 th block	Type of construction	F,P,T F = Flush, back of panel, open. P = Portable, floor, table mounting, air cooled with enclosure. T = In tank, immersed in oil.
5 th block	Provided with motor drive (M)	"Step-syn' 230V 1Ph AC 50Hz. 60rpm motor having instantaneous start-stop-reverse characteristics.
6 th block	Approx. time in secs. for full rotation sweep time.	8,15,30,45,60,120 (As per standard gear ratios available)

e.g.

75	D	3	T	M	15
----	---	---	---	---	----

 75 A Dimmerstat with 3 coils (Three phase) in oil-cooled tank construction with motor drive having 15s sweep.

e.g.

8	D	I	P
---	---	---	---

 8A Dimmerstat with 1 coil (single phase). Portable type & suitable for manual operation (no motorisation)

Similarly, other Dimmerstats can be configured & ordered.

INTRODUCTION

Dimmerstat is the Registered Trade Mark for the continuously variable voltage Auto Transformer, manufactured by AE. It is the most useful and effective device for stepless, breakless and continuous control of a.c. voltage. This widely known and highly acclaimed product, introduced more than 55 years ago, is an ideal controlling device for numerous applications in laboratories and in industrial & commercial fields.

The basic Dimmerstat is meant for operation of a nominal voltage of 240V A.C. and can give output voltage anywhere between 0 to 240V or upto 270V by a simple transformer action. three such Dimmerstats when connected electrically in star, and mechanically in tandem, become suitable for operation off 415V 3 Phase A.C. supply and to give output from zero to 415V or upto 470V.

SPECIAL FEATURES

Dimmerstat is the best device to obtain a continuously variable output voltage from a fixed a.c. voltage source. This is clearly evident from various special features and operating advantages, given below:

- Simple & rugged in construction - Therefore has long life, is relatively cheaper, noiseless in operation, compact and easy to understand, maintain and repair.
- Good regulation - Voltage drop on load is low, due to low resistance of conductor and low leakage flux of toroidal core.
- Output voltage variation on no-load and even on load is effortless, smooth, continuous, breakless and linearly proportional to angular rotation.
- High efficiency - No load losses and load losses are low.
- Negligible waveform and power factor distortion due to simple transformer action.
- Excellent short time overload capacity.
- Easy for remote operation with the help of motor drive.
- Wide range of models.

APPLICATIONS

- Dimmerstat, because of its unique characteristics and features find a very wide field of applications. A few of them are-
- Light control in auditoriums, hotels, restaurants, theatre stages, photo-studios, verandahs, lobbies, conference halls, cinema houses and even in homes.
- Voltage and current control in experimental and development work in laboratories and R & D Depts,
- Testing and calibration of indicating instruments.
- Current control for testing relays, current transformers, circuit breakers etc.
- Temperature control in ovens furnaces, moulding processes etc.
- Testing of electrical and electronic equipments for undervoltage and overvoltage performance.
- Breakdown testing of insulation.
- Control of D.C. Voltage in electrochemical processes, such as electroplating, battery plate forming, anodizing, metal refining hydrogenation, cathodic protection etc.
- Starting of A.C. motors.
- Speed control of D.C. motors in textile, plastic and paper industries and other extrusion processes.
- Servo Controlled A.C. Voltage Stabilizers and D.C. Power Supply Equipments.
- Phase Shifting Transformers.

For other applications and choice of models, where Dimmerstat is the best solution, consultancy and guidance can be provided by AE.

RATING AND SPECIFICATIONS

All single phase Dimmerstats are rated for 240V A.C. 50/60Hz. single phase supply and the three phase models for 415V A.C. 50/60Hz. three phase 4Wire supply.

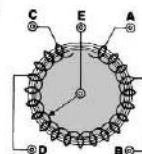

	FLUSH TYPE	PORTABLE TYPE
INPUT FOR 'LINE VOLTAGE'	A-C	C-A
INPUT FOR 'OVER VOLTAGE'	A-D	C-B
OUTPUT	A-E	C-E

CIRCUIT DIAGRAM FOR 1 PH DIMMERSTAT

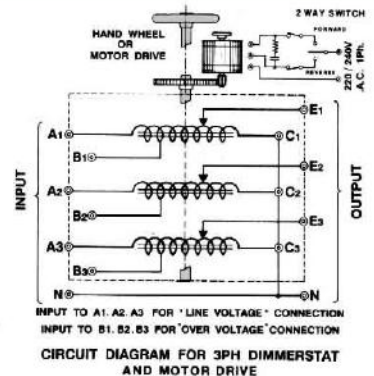

The output voltage can be varied smoothly over two ranges (i) from zero to full supply voltage (line voltage connection) or (ii) from zero to approx. 12% higher than the supply voltage (Over voltage Connection).

As the output voltage is continuously variable, Dimmerstats cannot be rated in terms of KVA but are rated in terms of current that can be drawn from the output. The rating assigned to a Dimmerstat generally indicates the max. output current that can be drawn for a short time and at an output voltage nearabout zero of nearabout the supply voltage value. The current that can be drawn from the output continuously and at any voltage, over the entire range, is generally lower in air cooled models. For all oil cooled models the two ratings are same. The table below gives the two corresponding ratings for air cooled models.

CURRENT RATINGS OF AIR COOLED MODELS								
Nominal Max. Current	0.7	2	4	8	10	15	20	25
Cont. Current	0.6	1.8	2.8	.5	9	11.5	16	22

Dimmerstats are suitable for indoor use in a maximum ambient temperature of 45 C they can also work at higher ambient temperature though at reduced output current rating. Dimmerstats can also be supplied for non-standard input and/or output voltages.

TYPES AND CONSTRUCTION

Basically Dimmerstat consists of a single layer of a high conductivity insulated copper wire, wound over an insulated toroidal core made of high grade C.R.G.O. silicon steel. The insulation on a particular portion of the wound coil is removed by precise grinding to form a commutator surface

over which the carbon brush traverses. The commutator surface is treated with a special precious metal plating process.

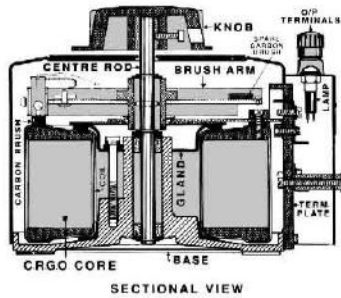

In case of models upto 28 amp. ratings, the commutator surface is formed on the coil. For higher ratings, in order to have larger contact area, the commutator is formed on the outer axial surface of the coil. Multiple brushes in parallel are employed to cover the full width of the area. Models of rating of 40 Amps. and above are made only in oil cooled construction.

CONSTRUCTIONAL DETAILS OF LARGE OIL COOLED DIMMERSTAT (ONE ELEMENT)

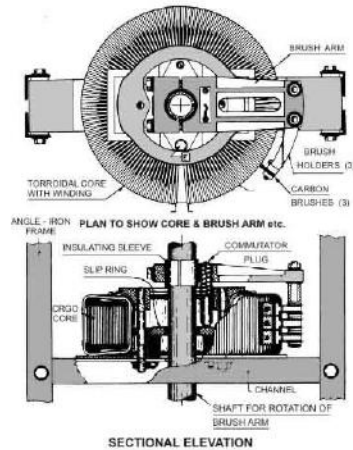

Single phase Dimmerstats are generally supplied in two types of construction, one is a portable type with sheet metal enclosure for mounting on table, floor or wall (type P). For mounting them flush or back of panel, or inside a cubicle, they are supplied without enclosure (typeF). For better cooling, or for continuous use at a fixed or nearabout fixed voltage, or even for protection against atmospheric effects. Dimmerstats are immersed in oil in a sheet steel tank

Ganged assemblies using 3 coils are used for 3 Phase Dimmerstat. these are also made in all types i.e. P.F. & T.

For higher ratings (above 200 Amps) two or three coils are used in parallel with load balancing arrangements. Against Specific requirements, Dimmerstats can also be supplied with 2 coils in series for operation of two phases or for independent outputs.

the details of standard types of Dimmerstats are given in the succeeding pages. All dimensions weights etc. are only approximate. For non-standard requirements, special offers can be made.

MOTOR DRIVE

Dimmerstats can be provided with a motor drive for the purpose of remote operation or automatic operation. the type of motor used is specially made for this application, it is a 240V A.C. synchronous stepper motor with a speed of 60 RPM at 50Hz. it can instantly start, reverse and stop without overrun. Gears between the motor and the Dimmerstat shaft are used to get a lower speed and hightertorque. the approximate time required for the full sweep of the brush is required to be specified, such as 8 Secs., 15 Secs., 30 Secs, etc upto 120 Secs.

CODING SYSTEM

A special coding system is adopted to identify the type and rating of the Dimmerstat. the first figure indicates the normal current rating, this is followed by latter 'D' denoting that is is a Dimmerstat. The third figure gives the no. of coils used in the assembly. the type of construction as explained earlier is indicated by the fourth letter. The code for manually operated Dimmerstat ends here, if the Dimmerstat is provided with a motor drive, the code is suffixed by letter 'M' followed by the figure that indicates the approx. time in seconds for full sweep of the brush arm.

For instance, Type 8D-1P indicates that is a 8 amps Dimmerstate with one coil (suitable for single phase), with portable sheet metal enclosure and suitable for manual operation. Similarly 75D-3TM15 means a 75 Amps. Dimmerstat with

3 coils (suitable for 3 Phase supply) in oil cooled construction, provided with motor drive having full sweep time of approx. 15 seconds.

MAINTENANCE

Even though Dimmerstats hae moving and rotating parts, they do not require any routine maintenance. The bearings are self lubricating and brushes are self aligning to take care of the wear. it is advised to clean the commutator surface periodically with clean cloth or with a smooth polish paper to get rid of the carbon deposit and to ensure that all turns are even and also to check free movement of the carbon brush inside the holder under spring pressure. All Dimmerstats above 2 amps rating are provided with a spare carbon brush inside. This will be handy in the event of a breakage of the brush. In case of oil for its electrical insulation level, normally once in a year, and, if necessary, the oil should be adequately filtered.

When operated with its rated capacity, Dimmerstat has long life, comparable to that of a fixed ratio conventional transformer for protection, it is advised to use a fast acting fuse at the output and a slow acting fuse at the input, so that proper protection can be provided without false blowing of fuse on account of switching surges.

0.7 D - 1F

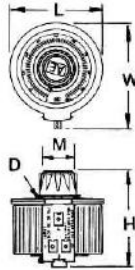

2D - 1F

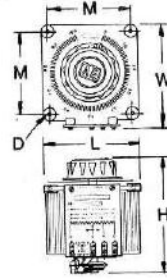

8D - 1F

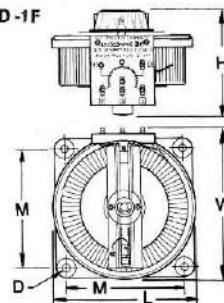

28D - 1F

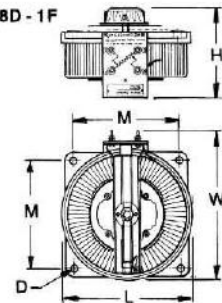

1 PHASE FLUSH MANUAL (AIR COOLED) 1F

Current Rating	0.7	2	4	8	19	15	20	28
L (mm)	84	109	175	175	192	220	250	295
W (mm)	98	120	190	190	210	240	290	345
H (mm)	87	127	130	153	153	180	205	205
M (mm)	28	92	146	146	154	178	204	238
D (mm)	5.0	6.5	11	11	11	11	13	13
Wt (kg)	1.1	3.0	5.8	7.5	9.8	13.8	17.3	23.3

0.7 D - 1F



2D - 1F



8D - 1F



2D - 1P

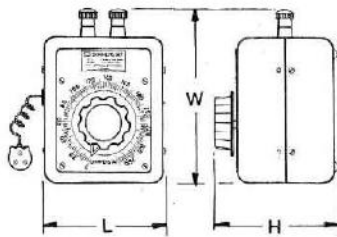

8D - 1P

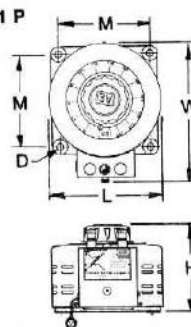

28D - 1P

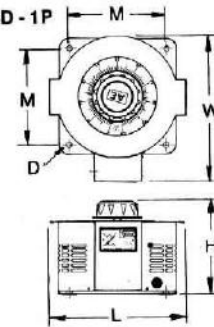

8D - 1P



1 PHASE PORTABLE MANUAL (AIR COOLED) 1P

Current Rating	2	4	8	10	15	20	28
L (mm)	134	178	178	195	227	285	356
W (mm)	186	220	220	235	265	305	356
H (mm)	140	140	155	160	185	200	215
M (mm)	-	146	146	154	176	204	238
D (mm)	-	11	11	11	11	13	13
Wt (kg)	3.8	8.2	8.5	10	24.8	19	25.8

2D - 1P



28D - 1P



60D - 1T

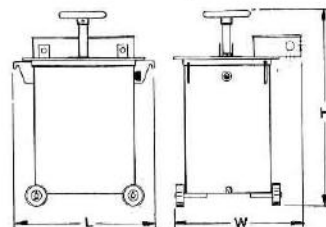

60D - 1T



1 PHASE PORTABLE MANUAL (OIL COOLED) - 1 T

Current Rating	40	50	60	75	100	125	150	200	300	400	500	600
L (mm)	590	720	720	836	835	835	835	835	1155	1255	1155	1255
W (mm)	610	610	610	670	840	840	865	1065	1190	1290	1190	1290
H (mm)	690	945	945	830	1115	1115	1165	1165	1330	1330	1630	1630
Wt (kg)	80	100	100	122	205	210	230	265	450	480	610	650
OIL (Ltrs.)	55	90	100	120	180	180	195	210	325	350	440	460

2 T

3 T

10D - 1FM

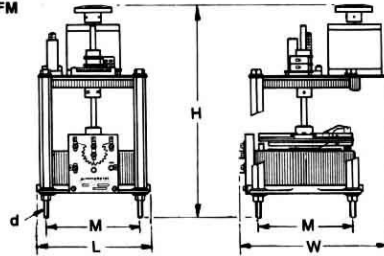

28D - 1FM



1 PHASE FLUSH MOTORISED (AIR COOLED) 1 FM

Current Rating	2	4	8	10	15	20	28
L (mm)	155	175	175	192	220	250	295
W (mm)	210	230	230	230	250	295	345
H (mm)	295	315	315	315	350	405	410
M (mm)	92	146	146	154	176	204	238
D (mm)	6.0	10	10	10	10	12	12
Wt (kg)	5.6	8.3	10.1	12.4	17	21.4	28.5

4D - 1PM

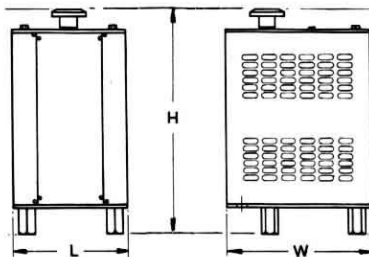

4D - 1PM



1 PHASE PORTABLE MOTORISED (AIR COOLED) -1PM

CURRENT Rating	2	4	8	10	15	20	28
L (mm)	190	190	190	210	240	305	380
W (mm)	240	240	240	265	305	375	435
H (mm)	350	350	350	350	375	465	475
Wt (kg)	11.5	14.6	16.6	19	25	35	44.6

40D - 1TM

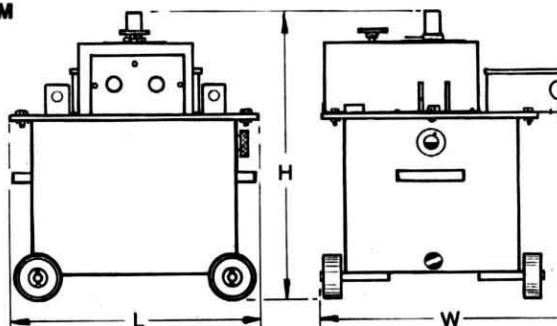

40D - 1TM

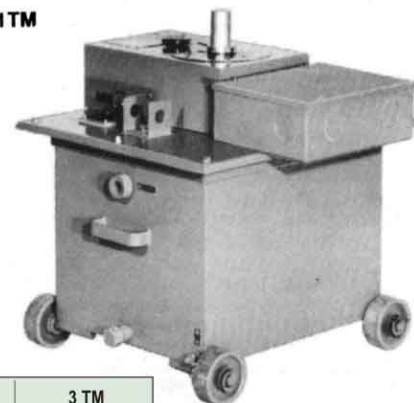

3 PHASE MOTORISED (OIL COOLED) - 1 TM

Current Rating	40	50	60	75	100	125	150	200	300	400	500	600
L (mm)	590	720	720	835	835	835	835	835	1155	1255	1155	1255
W (mm)	610	610	610	670	840	840	865	1065	1190	1290	1190	1290
H (mm)	680	935	935	812	1100	1100	1150	1150	1315	1315	1615	1615
Wt (kg)	90	110	110	132	215	220	140	275	460	690	620	660
OIL (Ltrs.)	55	90	100	120	180	180	195	210	325	350	440	460

8D - 3F

2D - 3F

28D - 3F

28D - 3F

3 PHASE FLUSH MANUAL (AIR COOLED) 3 F

Current Rating	2	4	8	10	15	20	28
L (mm)	109	175	175	192	220	250	295
W (mm)	120	190	190	210	140	190	345
H (mm)	390	485	485	485	530	585	600
M (mm)	92	146	146	154	176	204	238
D (mm)	6.0	10	10	10	10	12	12
Wt (kg)	9.6	18.4	24.5	29	42.6	55	71.2

28D - 3P

3 PHASE PORTABLE MANUAL (AIR COOLED) -3P

Current Rating	2	4	8	10	15	20	28
L (mm)	150	190	190	210	240	305	360
W (mm)	160	240	240	265	305	375	435
H (mm)	390	500	500	525	560	660	680
Wt (kg)	13	24	30.6	36	51.2	67.4	82.2

8D - 3P

28D - 3P

125D - 3T

100D - 3T

3 PHASE MANUAL (OIL COOLED) - 3 T

Current Rating	40	50	60	75	100	125	150	200	300	400
L (mm)	720	750	850	835	835	835	1055	1355	1640	1960
W (mm)	610	670	770	840	1040	1140	970	1270	1195	1515
H (mm)	1090	1090	1090	1440	1440	1440	1460	1460	1585	1585
Wt (kg)	150	170	185	345	355	370	490	590	1090	1190
OIL (Ltrs.)	115	125	130	245	270	275	330	385	850	925